

OPTIREG™ linear TLE4250-2G

Low drop voltage tracking regulator



Features

- 50 mA output current capability
- Tiny SMD-package PG-SCT595-5 with lowest thermal resistance
- Low output tracking tolerance
- Stable with small ceramic output capacitor
- Low dropout voltage
- Combined reference / enable input
- Low current consumption in stand-by mode
- Maximum input voltage $V_I = -42\text{ V to }+45\text{ V}$
- Reverse polarity protection
- Output short circuit proof to ground and supply
- Overtemperature protection
- Temperature range $T_j = -40^\circ\text{C to }150^\circ\text{C}$
- Green Product (RoHS compliant)



Potential applications

General automotive applications.

Product validation

Qualified for automotive applications. Product validation according to AEC-Q100/101.

Description

The OPTIREG™ linear TLE4250-2G is a monolithic integrated low dropout voltage tracker in a tiny SMD package PG-SCT595-5 with excellent thermal resistance. It is designed to supply off-board loads (e.g. sensors) in automotive environments. The IC protects itself in case of overload, overtemperature, reverse polarity as well as output short circuit to battery and ground. Supply voltages up to $V_I = 45\text{ V}$ are regulated to a reference voltage applied at the adjust input “ADJ” with high accuracy. The output “Q” is able to drive loads up to 50 mA. In order to reduce the quiescent current to a minimum, the TLE4250-2G can be switched to stand-by mode by setting the adjust/enable input “ADJ/EN” to “low”.

Type	Package	Marking
TLE4250-2G	PG-SCT595-5	52

Table of contents

	Features	1
	Potential applications	1
	Product validation	1
	Description	1
	Table of contents	2
1	Block diagram	3
2	Pin configuration	4
2.1	Pin assignment	4
2.2	Pin definitions and functions	4
3	General product characteristics	5
3.1	Absolute maximum ratings	5
3.2	Functional range	6
3.3	Thermal resistance	6
4	Electrical characteristics	7
4.1	Tracking regulator	7
4.2	Current consumption	13
4.3	Adjust / enable input	15
5	Package information	16
6	Revision history	17

Block diagram

1 Block diagram

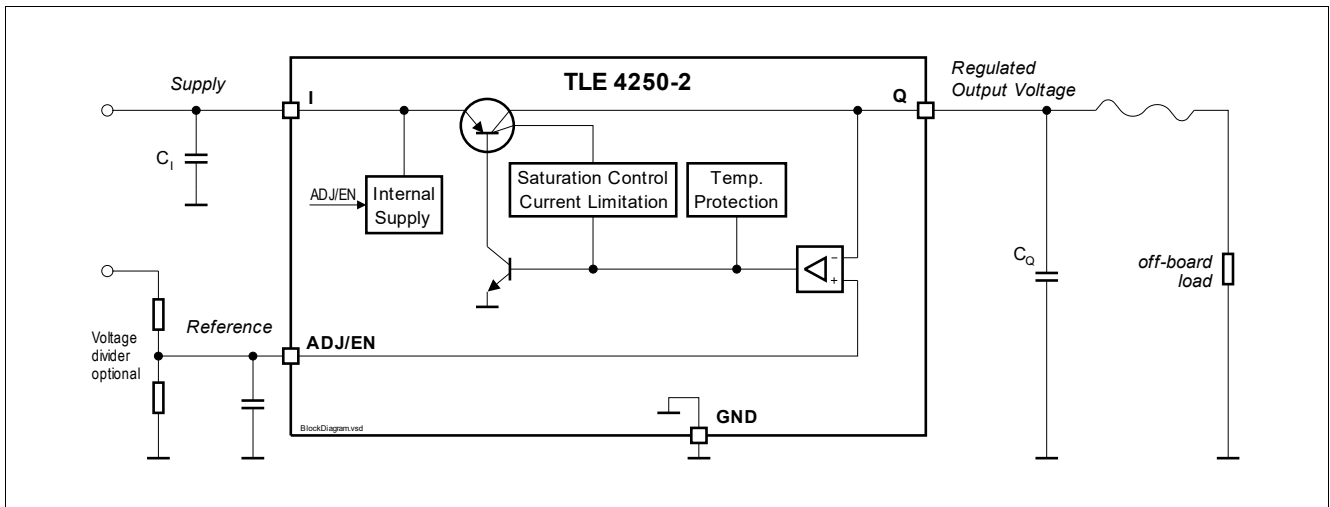

Figure 1 Block diagram and simplified typical application

Pin configuration

2 Pin configuration

2.1 Pin assignment

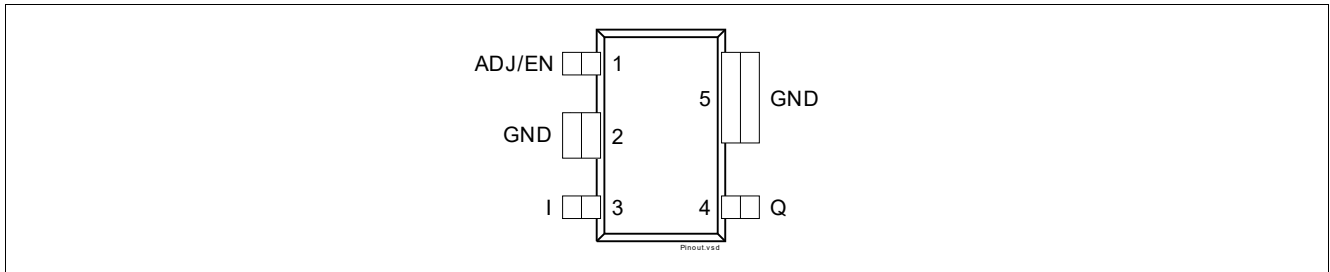

Figure 2 Pin configuration package PG-SCT595-5

2.2 Pin definitions and functions

Pin	Symbol	Function
1	ADJ/EN	Adjust / enable. Connect the reference to this pin. A low signal disables the IC; a high signal switches it on. The reference voltage can be connected directly or by a voltage divider for lower output voltages. For compensating line influences, a capacitor close to the IC pins is recommended.
2	GND	Ground reference. Internally connected to Pin 5. Connect to heatsink area.
3	I	Input. IC supply. For compensating line influences, a capacitor close to the IC pins is recommended.
4	Q	Tracker output. Block to GND with a capacitor close to the IC terminals, respecting capacitance and ESR requirements given in the table “ Functional range ”.
5	GND	Ground reference. Internally connected to Pin 2. Connect to heatsink area.

General product characteristics

3 General product characteristics

3.1 Absolute maximum ratings

Table 1 Absolute maximum ratings ¹⁾

$T_j = -40^\circ\text{C}$ to 150°C ; all voltages with respect to ground (unless otherwise specified).

Parameter	Symbol	Values			Unit	Note or Test Condition	Number
		Min.	Typ.	Max.			
Voltages							
Input voltage	V_I	-42	-	45	V	-	P_3.1.1
Output voltage	V_Q	-1	-	40	V	-	P_3.1.2
Adjust / enable input	$V_{\text{ADJ/EN}}$	-0.3	-	40	V	-	P_3.1.3
Temperatures							
Junction temperature	T_j	-40	-	150	$^\circ\text{C}$	-	P_3.1.4
Storage temperature	T_{stg}	-50	-	150	$^\circ\text{C}$	-	P_3.1.5
ESD susceptibility							
ESD resistivity	$V_{\text{ESD,HBM}}$	-3	-	3	kV	HBM ²⁾	P_3.1.6
	$V_{\text{ESD,CDM}}$	-2	-	2	kV	CDM ³⁾	P_3.1.7

1) Not subject to production test, specified by design.

2) ESD susceptibility, Human Body Model “HBM” according to EIA/JESD 22-A114B.

3) ESD susceptibility, Charged Device Model “CDM” according to EIA/JESD22-C101 or ESDA STM5.3.1.

Notes

1. Stresses above the ones listed here may cause permanent damage to the device. Exposure to absolute maximum rating conditions for extended periods may affect device reliability.
2. Integrated protection functions are designed to prevent IC destruction under fault conditions described in the data sheet. Fault conditions are considered as “outside” normal operating range. Protection functions are not designed for continuous repetitive operation.

General product characteristics

3.2 Functional range

Table 2 Functional range

Parameter	Symbol	Values			Unit	Note or Test Condition	Number
		Min.	Typ.	Max.			
Input voltage	V_I	4	–	40	V	–	P_3.2.1
Adjust / enable input voltage (Voltage tracking range)	$V_{ADJ/EN}$	2.5	–	36	V	–	P_3.2.2
Junction temperature	T_j	-40	–	150	°C	–	P_3.2.3
Output capacitor requirements	C_Q	1	–	–	μF	– ¹⁾	P_3.2.4
	ESR_{CQ}	–	–	3	Ω	– ²⁾	P_3.2.5

1) The minimum output capacitance requirement is applicable for a worst case capacitance tolerance of 30%.

2) Relevant ESR value at $f = 10$ kHz.

Note: Within the functional range the IC operates as described in the circuit description. The electrical characteristics are specified within the conditions given in the related electrical characteristics table.

3.3 Thermal resistance

Table 3 Thermal resistance

Parameter	Symbol	Values			Unit	Note or Test Condition	Number
		Min.	Typ.	Max.			
Junction to ambient	R_{thJA}	–	81	–	K/W	2s2p board ¹⁾	P_3.3.1
		–	217	–	K/W	Footprint only ²⁾	P_3.3.2
		–	117	–	K/W	300 mm ² PCB heatsink area ²⁾	P_3.3.3
		–	103	–	K/W	600 mm ² PCB heatsink area ²⁾	P_3.3.4
Junction to soldering point	R_{thJSP}	–	30	–	K/W	Pins 2, 5 fixed to T_A	P_3.3.5

1) Specified R_{thJA} value is according to JESD51-2,-5,-7 at natural convection on FR4 2s2p board; The product (chip+package) was simulated on a 76.2 × 114.3 × 1.5 mm board with 2 inner copper layers (2 × 70 μm Cu, 2 × 35 μm Cu).

Where applicable a thermal via array under the package contacted the first inner copper layer.

2) Package mounted on PCB FR4; 80 × 80 × 1.5 mm; 35 μm Cu, 5 μm Sn; horizontal position; zero airflow. Not subject to production test; specified by design.

Electrical characteristics

4 Electrical characteristics

4.1 Tracking regulator

The output voltage V_Q is controlled by comparing it to the voltage applied at pin ADJ/EN and driving a PNP pass transistor accordingly. The control loop stability depends on the output capacitor C_Q , the load current, the chip temperature and the poles/zeros introduced by the integrated circuit. To ensure stable operation, the output capacitor's capacitance and its equivalent series resistor ESR requirements given in the table "Functional range" have to be maintained. For details see also the typical performance graph "Output capacitor series resistor ESR_{CQ} vs. output current I_Q ". Also, the output capacitor shall be sized to buffer load transients.

An input capacitor C_I is recommended to buffer line influences. Connect the capacitors close to the IC terminals.

Protection circuitry prevent the IC as well as the application from destruction in case of catastrophic events. These safeguards contain output current limitation, reverse polarity protection as well as thermal shutdown in case of overtemperature.

In order to avoid excessive power dissipation that could never be handled by the pass element and the package, the maximum output current is decreased at high input voltages.

The overtemperature protection circuit prevents the IC from immediate destruction under fault conditions (e. g. output continuously short-circuited) by reducing the output current. A thermal balance below 200°C junction temperature is established. Please note that a junction temperature above 150°C is outside the maximum ratings and reduces the IC lifetime.

The TLE4250-2G allows a negative supply voltage. However, several small currents are flowing into the IC. For details see electrical characteristics table and typical performance graphs. The thermal protection circuit is not operating during reverse polarity condition.

Table 4 Electrical characteristics tracking regulator

$V_I=13.5\text{ V}$; $V_{ADJ/EN} \geq 2.5\text{ V}$; $T_j = -40^\circ\text{C}$ to 150°C

all voltages with respect to ground (unless otherwise specified).

Parameter	Symbol	Values			Unit	Note or Test Condition	Number
		Min.	Typ.	Max.			
Output voltage tracking accuracy	ΔV_Q	-5	-	5	mV	$1\text{ mA} \leq I_Q \leq 10\text{ mA}$; $6\text{ V} \leq V_I \leq 16\text{ V}$	P_4.1.1
		-25	-	25	mV	$1\text{ mA} I_Q \leq 50\text{ mA}$; $6\text{ V} \leq V_I \leq 28\text{ V}$	P_4.1.2
		-25	-	25	mV	$1\text{ mA} \leq I_Q \leq 10\text{ mA}$; $6\text{ V} \leq V_I \leq 40\text{ V}$	P_4.1.3
Load regulation steady-state	$ \Delta V_{Q,load} $	-	-	15	mV	$I_Q = 1\text{ mA}$ to 30 mA ;	P_4.1.4
Line regulation steady-state	$ \Delta V_{Q,line} $	-	-	10	mV	$V_I = 6\text{ V}$ to 40 V ; $I_Q = 10\text{ mA}$	P_4.1.5
Power supply ripple rejection	PSRR	-	48	-	dB	$f_{\text{ripple}} = 100\text{ Hz}$; $V_{\text{ripple}} = 1\text{ Vpp}$ ¹⁾	P_4.1.6
Dropout voltage $V_{dr} = V_I - V_Q$	V_{dr}	-	100	300	mV	$I_Q = 10\text{ mA}$; $V_{ADJ} \geq 4\text{ V}$ ²⁾	P_4.1.7

Electrical characteristics

Table 4 Electrical characteristics tracking regulator

$V_I=13.5\text{ V}$; $V_{ADJ/EN} \geq 2.5\text{ V}$; $T_j = -40^\circ\text{C}$ to 150°C

all voltages with respect to ground (unless otherwise specified).

Parameter	Symbol	Values			Unit	Note or Test Condition	Number
		Min.	Typ.	Max.			
Output current limitation	$I_{Q,max}$	51	85	120	mA	$V_Q = (V_{ADJ} - 0.1\text{ V})$	P_4.1.8
Reverse current	I_Q	-5	-1	-	mA	$V_I = 0\text{ V}$; $V_Q = 16\text{ V}$; $V_{ADJ} = 5\text{ V}$	P_4.1.9
Reverse current at negative input voltage	I_I	-10	-2	-	mA	$V_I = -16\text{ V}$; $V_Q = 0\text{ V}$; $V_{ADJ} = 5\text{ V}$	P_4.1.10
Overtemperature protection							
Junction temperature	$T_{j,eq}$	151	-	200	$^\circ\text{C}$	T_j increasing due to power dissipation generated by the IC ¹⁾	P_4.1.11

1) Parameter not subject to production test; specified by design.

2) Measured when the output voltage V_Q has dropped 100 mV from its nominal value.

Electrical characteristics

Typical performance characteristics tracking regulator $V_{ADJ/EN} = 5\text{ V}$ (unless otherwise noted)

Output voltage V_Q vs. adjust voltage V_{ADJ}

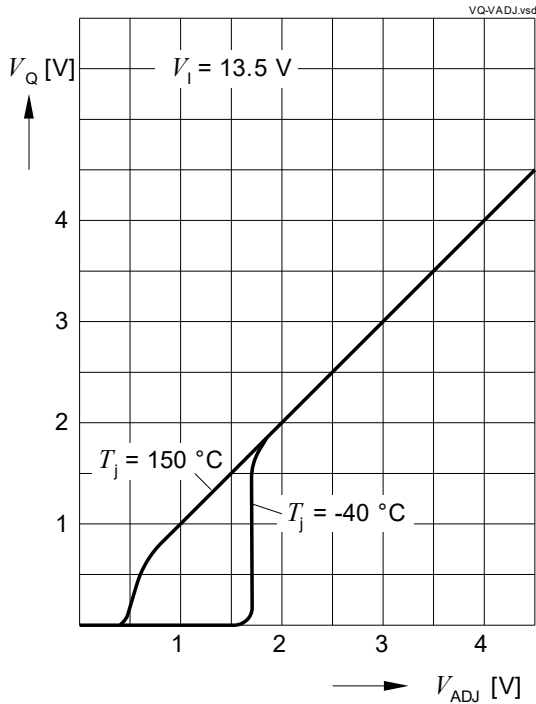

Output voltage V_Q vs. input voltage V_I

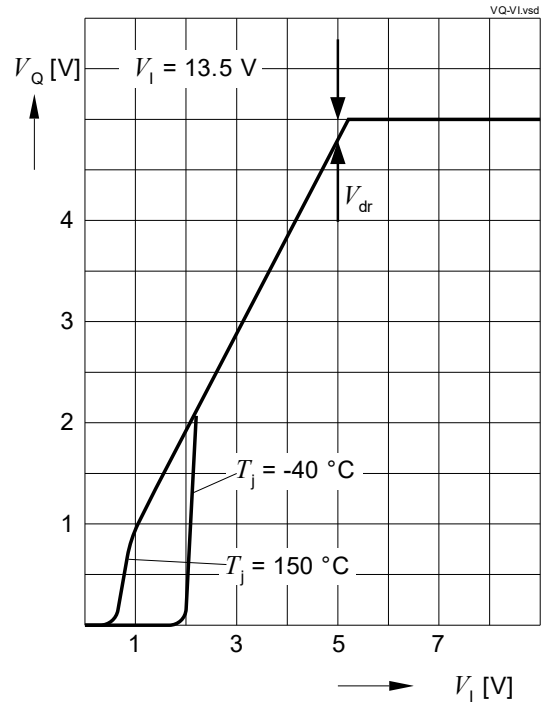

Maximum output current I_Q vs. input voltage V_I

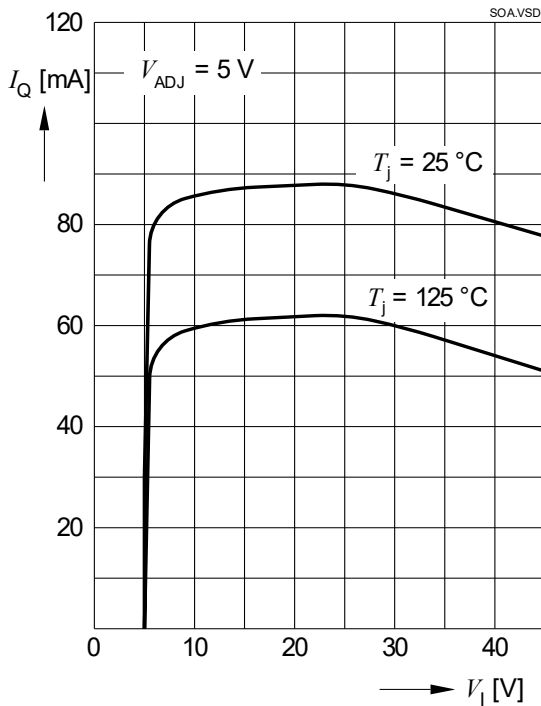

Line regulation $\Delta V_{Q,line}$ vs. input voltage change ΔV_I

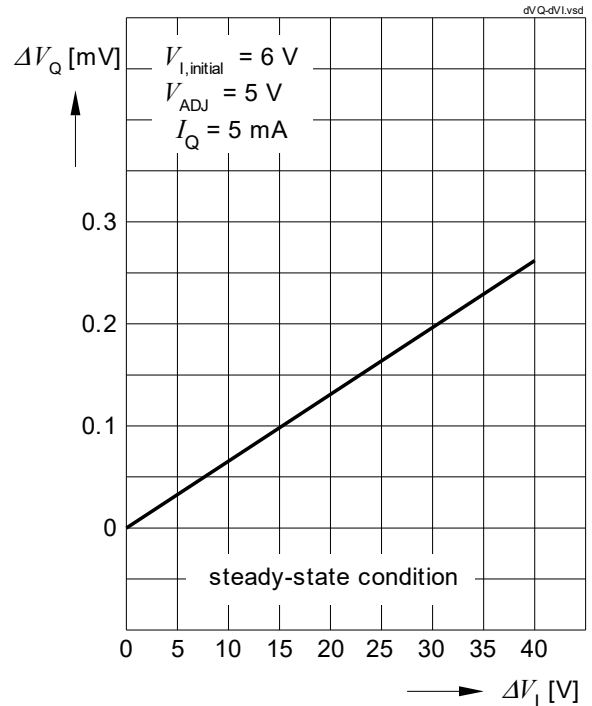

Electrical characteristics

Load regulation $\Delta V_{Q,line}$ vs. output current change dI_Q

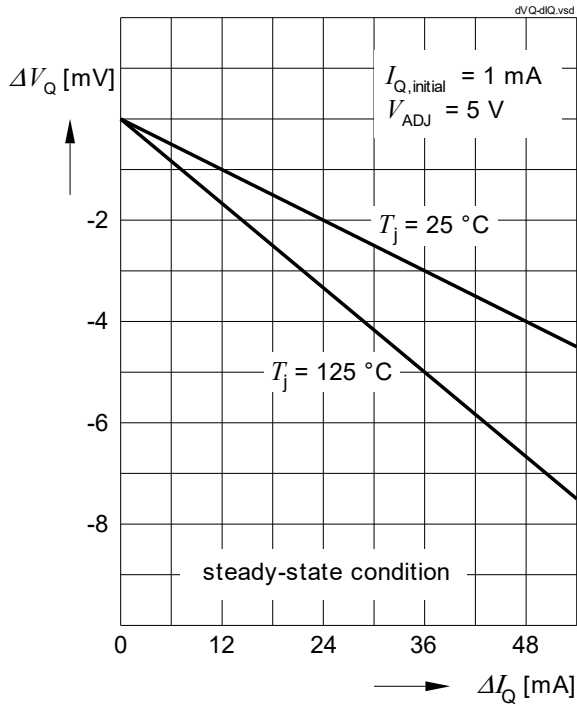

Output capacitor series resistor ESR_{CQ} vs. output current I_Q

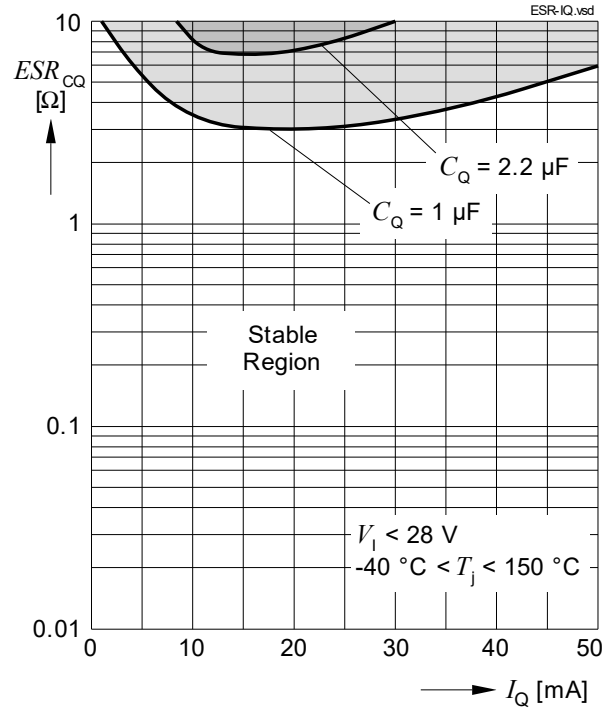

Line transient response

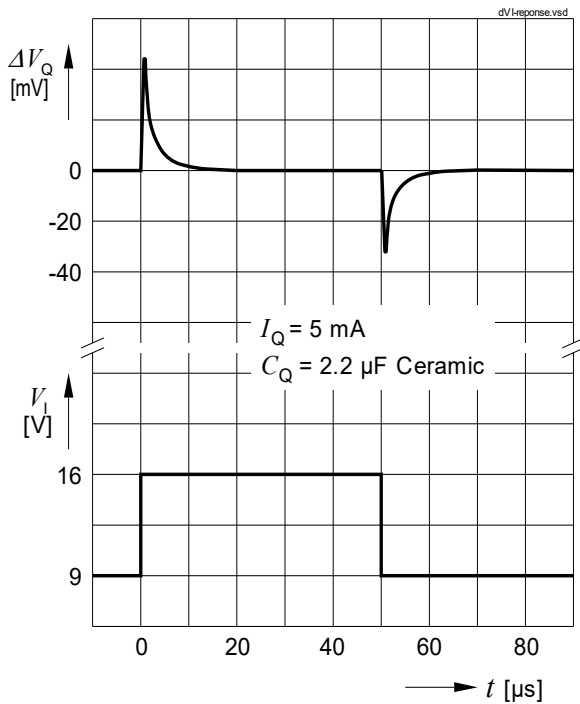

Load transient response

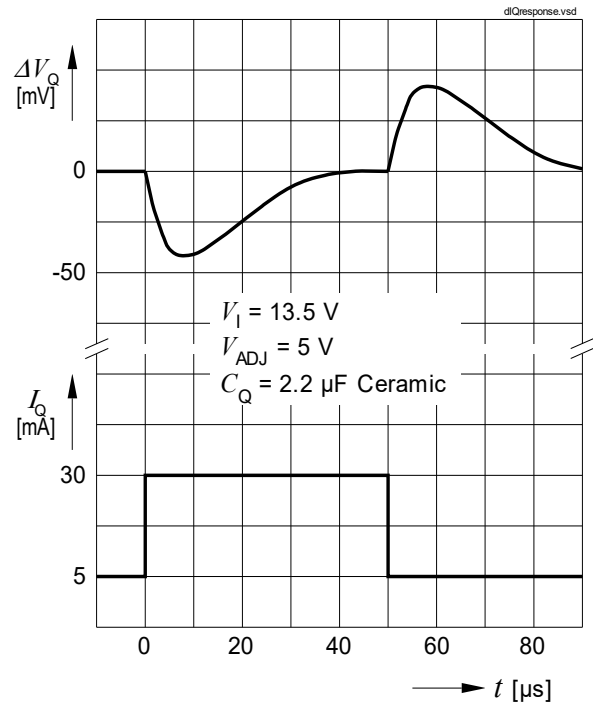

Electrical characteristics

Tracking accuracy ΔV_Q vs. junction temperature T_j

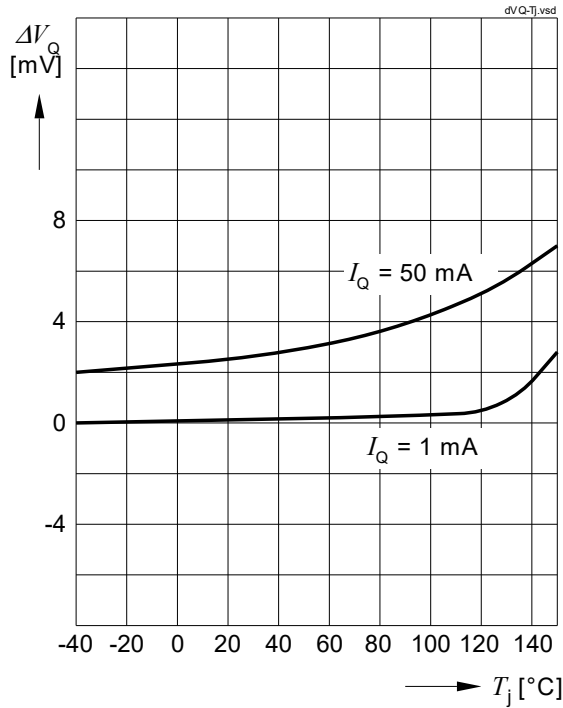

Dropout voltage V_{dr} vs. output current I_Q

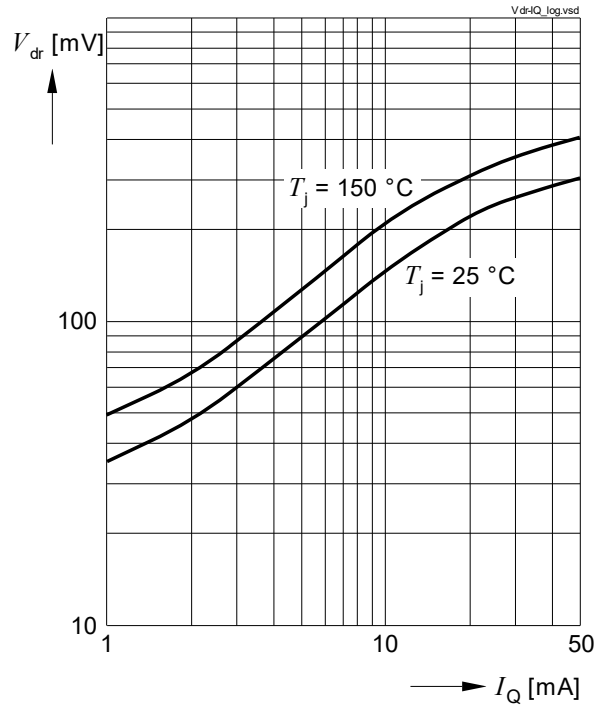

Dropout voltage V_{dr} vs. junction temperature T_j

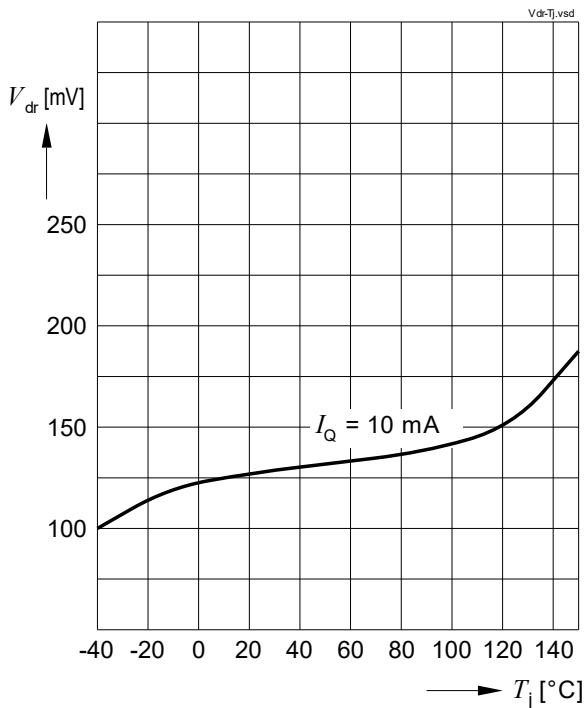

Output current limitation $I_{Q,max}$ vs. output voltage V_Q

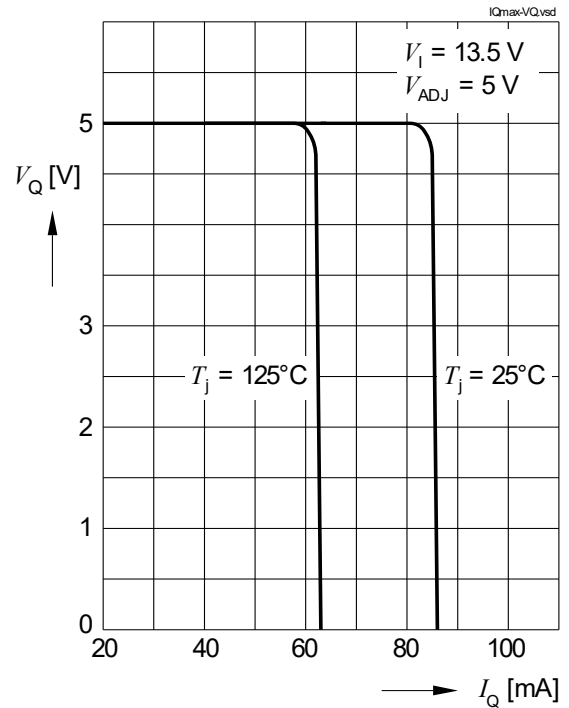

Electrical characteristics

Reverse output current I_Q vs. output voltage V_Q

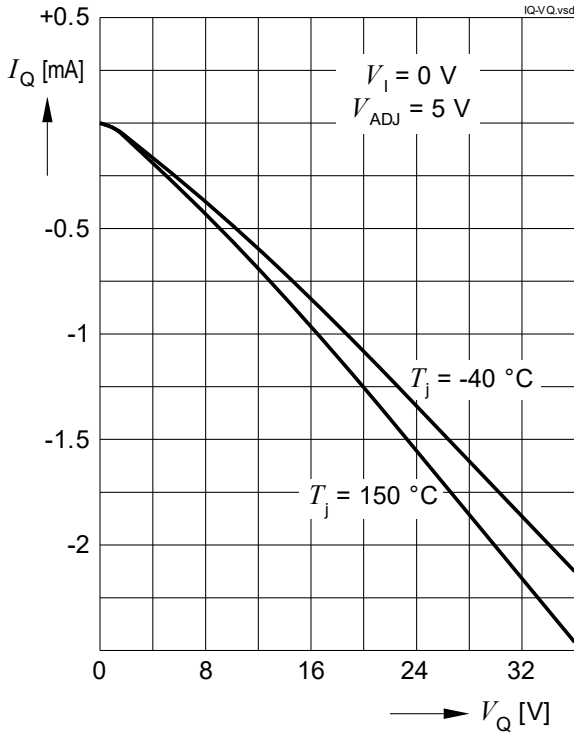

Reverse current I_I vs. input voltage V_I

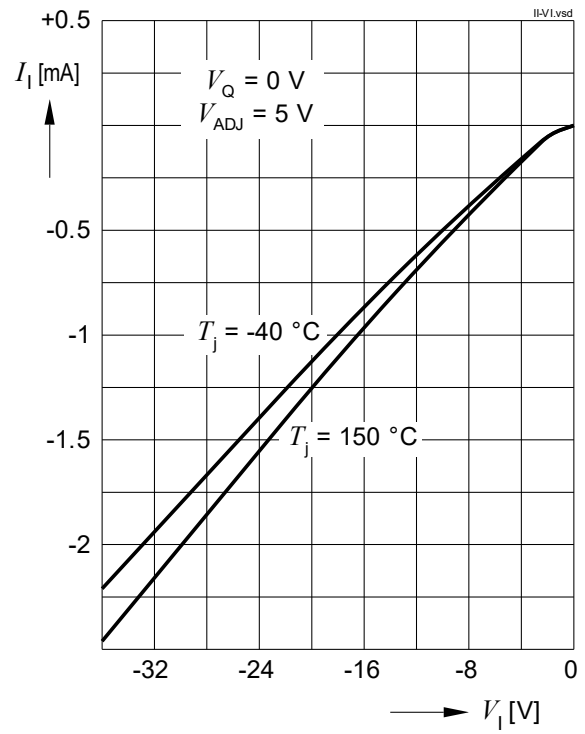

Power supply ripple rejection $PSRR$

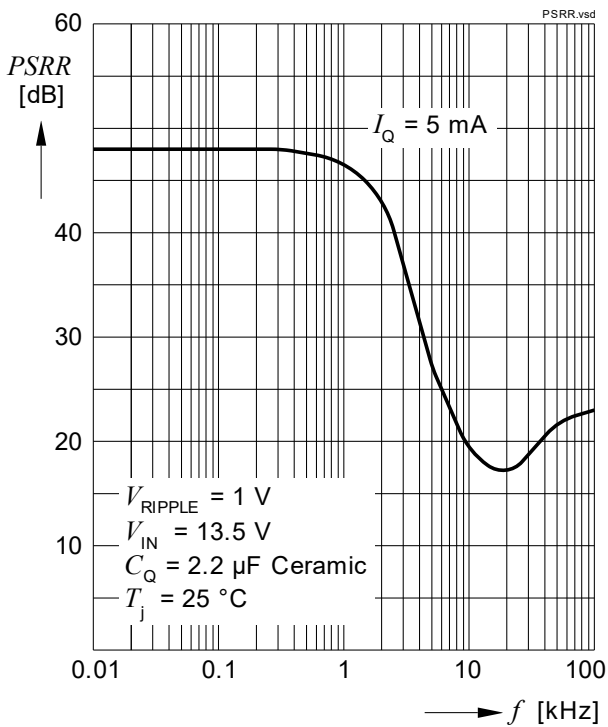

Electrical characteristics

4.2 Current consumption

Table 5 Electrical characteristics current consumption

$V_I=13.5\text{ V}$; $V_{ADJ/EN} \geq 2.5\text{ V}$; $T_j = -40^\circ\text{C}$ to 150°C

all voltages with respect to ground (unless otherwise specified).

Parameter	Symbol	Values			Unit	Note or Test Condition	Number
		Min.	Typ.	Max.			
Quiescent current stand-by mode	I_{q1}	–	10	20	μA	$V_{ADJ/EN} \leq 0.4\text{ V}$; $T_j \leq 85^\circ\text{C}$	P_4.2.1
Current consumption $I_q = I_I - I_Q$	I_{q2}	–	140	200	μA	$I_Q \leq 1\text{ mA}$;	P_4.2.2
		–	3	5	mA	$I_Q \leq 30\text{ mA}$;	P_4.2.3
Current consumption dropout region; $I_q = I_I - I_Q$	I_{q3}	–	1	2	mA	$V_{ADJ} = V_I = 5\text{ V}$; $I_Q = 0\text{ mA}$	P_4.2.4

Electrical characteristics

Typical performance characteristics current consumption $V_{ADJ/EN} = 5\text{ V}$ (unless otherwise noted)

Current consumption I_{q1}, I_{q2} vs. junction temperature T_j

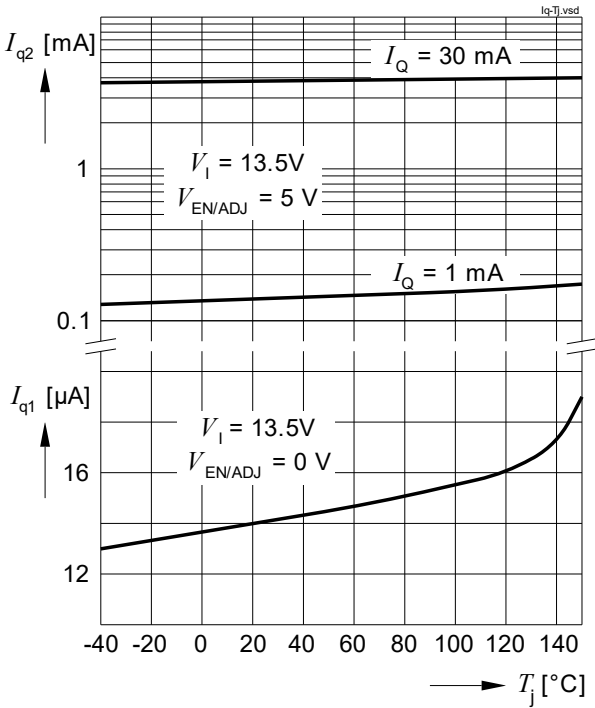

Current consumption I_{q2} vs. output current I_Q

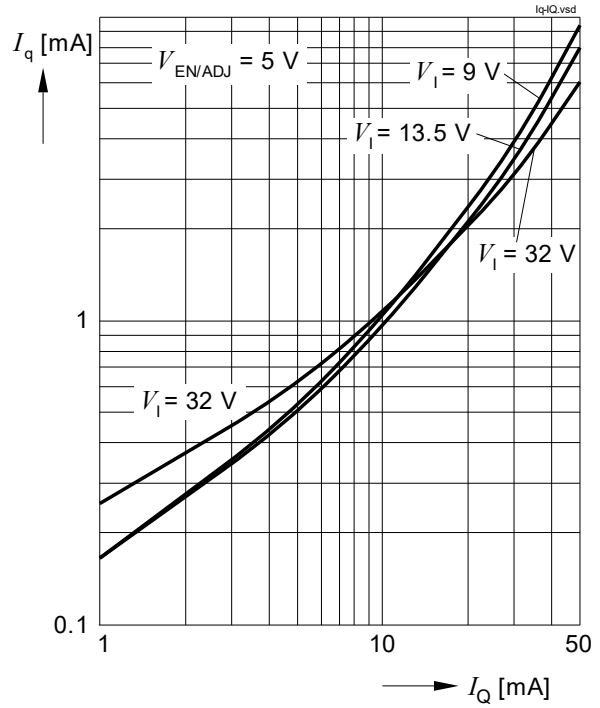

Current Consumption I_{q2} vs. input voltage V_i

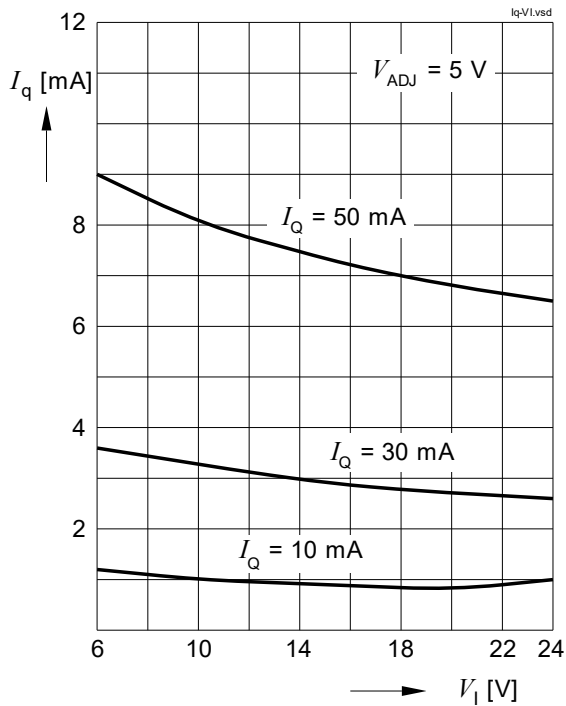

Electrical characteristics

4.3 Adjust / enable input

In order to reduce the quiescent current to a minimum, the TLE4250-2G can be switched to stand-by mode by setting the adjust/enable input “ADJ/EN” to “low”.

Table 6 Electrical characteristics adjust / enable

$V_I=13.5\text{ V}$; $V_{ADJ/EN} \geq 2.5\text{ V}$; $T_j = -40^\circ\text{C}$ to 150°C

all voltages with respect to ground, positive current flowing into pin (unless otherwise specified).

Parameter	Symbol	Values			Unit	Note or Test Condition	Number
		Min.	Typ.	Max.			
Adjust / enable input current	I_{ADJ}	–	0.1	0.5	μA	$V_{ADJ} = 5\text{ V}$;	P_4.3.1
Adjust / enable low signal valid	$V_{ADJ,low}$	–	–	0.4	V	$V_Q = 0\text{ V}$;	P_4.3.2
Adjust / enable high signal valid (tracking region)	$V_{ADJ,high}$	2.5	–	36	V	$ V_Q - V_{ADJ} < 25\text{ mV}$;	P_4.3.3

Typical performance characteristics adjust / enable input $V_{ADJ/EN} = 5\text{ V}$ (unless otherwise noted)

Startup sequence

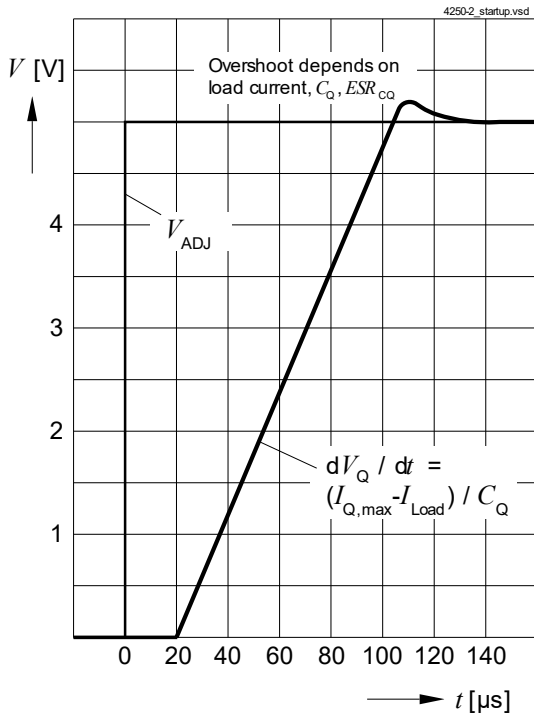

Revision history

6 Revision history

Revision	Date	Changes
1.1	2022-03-08	Update layout, editorial changes
1.0	2007-07-24	Final datasheet initial version

Trademarks

All referenced product or service names and trademarks are the property of their respective owners.

Edition 2022-03-08

Published by

Infineon Technologies AG

81726 Munich, Germany

© 2022 Infineon Technologies AG.

All Rights Reserved.

Do you have a question about any aspect of this document?

Email: erratum@infineon.com

Document reference

Z8F55246831

IMPORTANT NOTICE

The information given in this document shall in no event be regarded as a guarantee of conditions or characteristics ("Beschaffheitsgarantie").

With respect to any examples, hints or any typical values stated herein and/or any information regarding the application of the product, Infineon Technologies hereby disclaims any and all warranties and liabilities of any kind, including without limitation warranties of non-infringement of intellectual property rights of any third party.

In addition, any information given in this document is subject to customer's compliance with its obligations stated in this document and any applicable legal requirements, norms and standards concerning customer's products and any use of the product of Infineon Technologies in customer's applications.

The data contained in this document is exclusively intended for technically trained staff. It is the responsibility of customer's technical departments to evaluate the suitability of the product for the intended application and the completeness of the product information given in this document with respect to such application.

For further information on technology, delivery terms and conditions and prices, please contact the nearest Infineon Technologies Office (www.infineon.com).

WARNINGS

Due to technical requirements products may contain dangerous substances. For information on the types in question please contact your nearest Infineon Technologies office.

Except as otherwise explicitly approved by Infineon Technologies in a written document signed by authorized representatives of Infineon Technologies, Infineon Technologies' products may not be used in any applications where a failure of the product or any consequences of the use thereof can reasonably be expected to result in personal injury.

Mouser Electronics

Authorized Distributor

Click to View Pricing, Inventory, Delivery & Lifecycle Information:

[Infineon:](#)

[TLE4250-2G](#) [TLE42502GH TSA1](#)